

Fluid control valve(2/2way)

2W Series (Direct-acting and normally closed)



Symbol



Product feature

1. Direct acting and normally closed type 2/2 way solenoid valve. Its high sensibility allows it to change direction quickly;
2. It has wide pressure range, including extra high pressure (X), high pressure (H), standard, large volume(L) and extra large volume (T) to choose from;
3. It is compact, small size and light weight. It is easy to install and dismantle.
4. The valve body is made of brass. Its coil has a Heat resistance classification of Class B. The standard seal material is FPM-F. Please contact us if other material are required.
5. The protection class of the coil is IP65 and there is a choice for grommet or terminal electrical entry.

Inner structure

2W030 (Terminal)

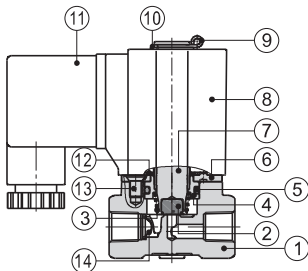

No.	Item	No.	Item
1	Body	8	Coil assembly
2	Airtight ring	9	E Clip
3	Spring	10	Gasket
4	Fixed cap	11	Connector
5	O-ring	12	Washer
6	Fixed plate	13	Screw
7	Movable core	14	Filter [Note]

[Note] Extra large volume type has no filter element.

Ordering code

Ordering code of valves

2W L 030 08 A □ G



① Model	② Pressure condition	③ Size series	④ Port size	⑤ Voltage	⑥ Electrical entry	⑦ Thread type
2W: 2/2 way direct-acting and normally closed	X: Extra high pressure H: High pressure Blank: Standard L: Large volume T: Extra large volume	030: 030 Series	06: 1/8" 08: 1/4"	A: AC220V B: DC24V C: AC110V E: AC24V F: DC12V	Blank: Terminal I: Grommet	G: G
		050: 050 Series	10: 3/8" 15: 1/2"			

Ordering code of accessories

Ordering code of accessories is the same as 2S series valve's, Please refer to P117 for details of ordering code.

Specification

Model\Item	Port size [Note1]	Orifice size (Φmm)	Cv	Valid area or section (mm ²)	Weight [Note2](g)	Max. operating pressure differential		Proof pressure	
						MPa	psi	MPa	psi
2WX030	-06 1/8"	1.5	0.10	1.8	305	3.0	450	5.0	750
	-08 1/4"								
2WH030	-06 1/8"	2.0	0.18	3.0	305	2.0	300		
	-08 1/4"								
2W030	-06 1/8"	3.0	0.33	6.0	305	1.0	150		
	-08 1/4"								
2WL030	-06 1/8"	4.0	0.55	10.0	305	0.5	75		
	-08 1/4"								
2WT030	-06 1/8"	6.0	1.10	12.0	305	0.1	15		
	-08 1/4"								
2WX050	-10 3/8"	3.0	0.34	6.1	620	3.0	450		
	-15 1/2"								
2WH050	-10 3/8"	4.0	0.55	10.0	620	2.0	300		
	-15 1/2"								
2W050	-10 3/8"	5.0	0.83	15.0	620	1.0	150		
	-15 1/2"								
2WL050	-10 3/8"	7.0	1.40	25.0	620	0.5	75		
	-15 1/2"								
2WT050	-10 3/8"	10.0	2.20	40.0	620	0.1	15		
	-15 1/2"								

[Note1] G thread is available.

[Note2] The weight in the table is the terminal valve's weight, 2W030 series grommet valve's weight is 10g less than terminal's. 2W050series grommet valve's weight is 20g less than terminal's.

Specification of coil

Valve type	Coil type	Power type	Frequency (Hz)	Voltage range	Electrical entry	Power Consumption (VA/W)	Insulation	Temp. rise(°C)	
2W□030	CDA116 CLA116	AC	50	± 15%	Terminal (CDA)	10.0VA	Class B	35	
			60			8.0VA		30	
2W□050	CDA170 CLA170	AC	50	± 15%		Grommet (CLA)		6.5W	30
			60					25.0VA	60
		DC	-	± 10%		10.5W	55		
							40		

Valve's specification

Acting		Direct acting				
Initial state		Normally closed				
Adaptable fluid [Note1]		Air, Water, Oil				
Viscosity limit		Under 20CST				
Ambient and fluid temperature (°C)		Water	Air	Oil	Ambient	
	Max.	80	90	80	70	
	Min.	1	-20 [Note2]	-10 [Note3]	-20	

[Note1] Please refer to P142 for detail of other's fluid;

[Note2] Dew point: -20(°C) or less;

[Note3] 50CST or less.



Fluid control valve(2/2way)

2W Series (Direct-acting and normally closed)

Flow chart

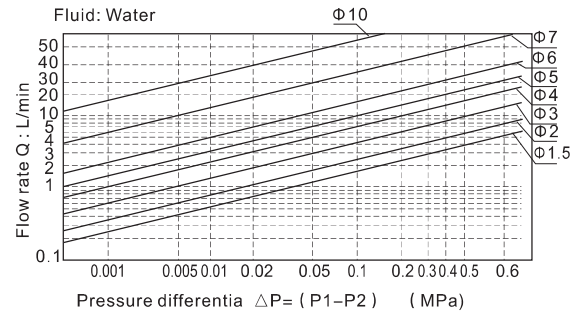
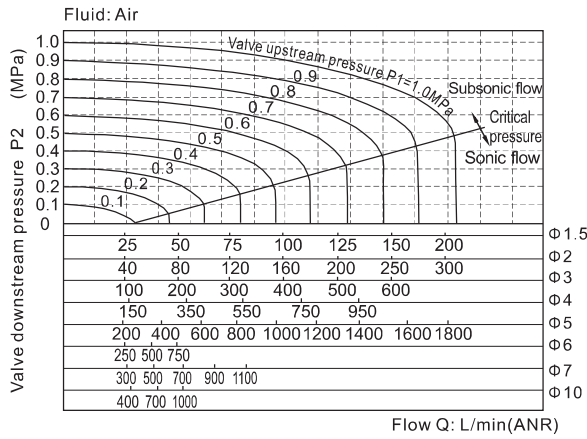

Dimensions

2W□030 (Terminal)

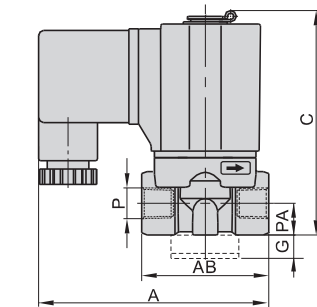
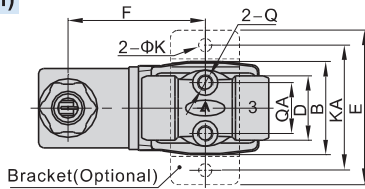

2W□030 (Grommet)

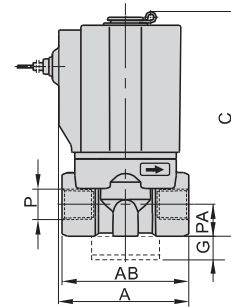
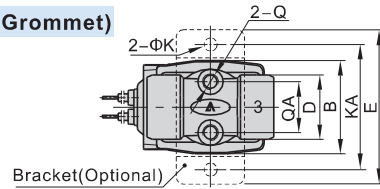

2W□050 (Terminal)

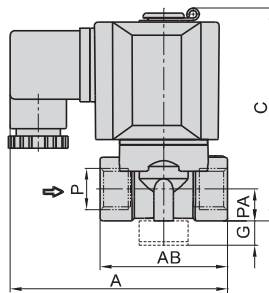
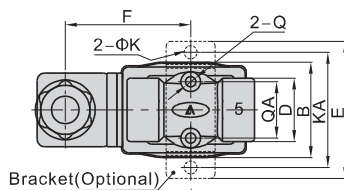

2W□050 (Grommet)

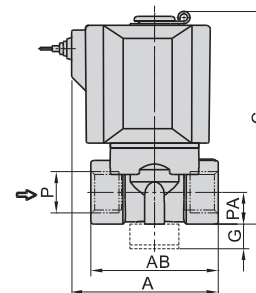
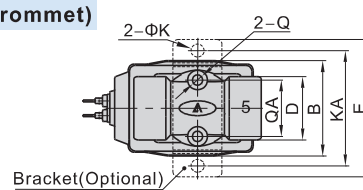

Model\Item	A	AB	B	C	D	E	F	G	K	KA	P	PA	Q	QA
2W□030-06	72.5	40	29.5	71	20	49	43.5	10	5.3	40	1/8"	10	M5	16
2W□030-08	72.5	40	29.5	71	20	49	43.5	10	5.3	40	1/4"	10	M5	16
2W□050-10	89.5	52	39	87	26	56	51	10	5.3	48	3/8"	13	M5	23
2W□050-15	89.5	52	39	87	26	56	51	10	5.3	48	1/2"	13	M5	23

Model\Item	A	AB	B	C	D	E	G	K	KA	P	PA	Q	QA
2W□030-06	41	40	29.5	71	20	49	10	5.3	40	1/8"	10	M5	16
2W□030-08	41	40	29.5	71	20	49	10	5.3	40	1/4"	10	M5	16
2W□050-10	60	52	39	87	26	56	10	5.3	48	3/8"	13	M5	23
2W□050-15	60	52	39	87	26	56	10	5.3	48	1/2"	13	M5	23